

Data Sheet



Article number: 0125093

Description: Retaining ring SP90
Spring steel

Measures

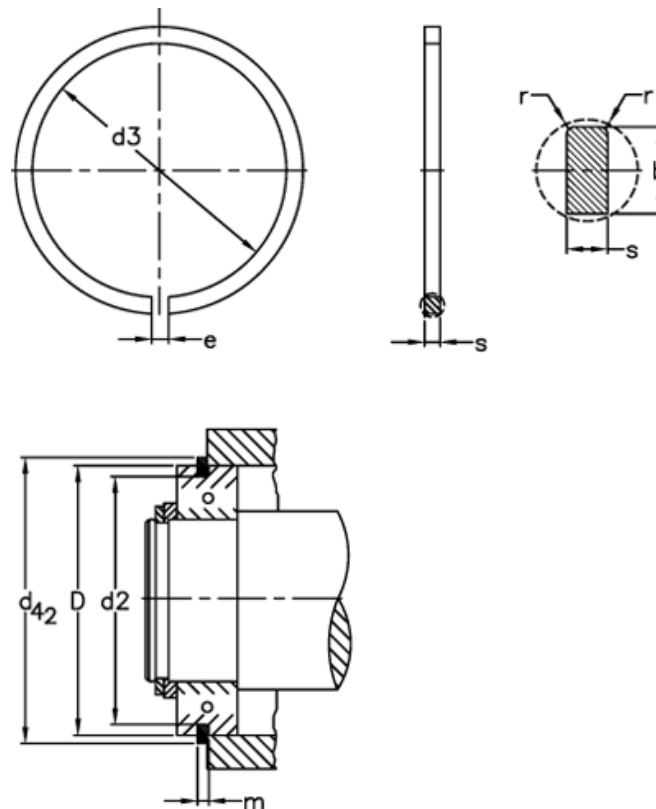

b	= 4.85	FRg kN	= 14.80	tol	= -0.15
D	= 90	FR kN	= 93.9	tol	= -0.1
d2	= 86.79	g	= 3.0	tol	= -0.50
d3	= 85.4	K kN-mm	= 174.0	tol	= 0.3
d42	= 96.5	m	= 2.70	tol	= 0.8
Description	= SP 90	n abl x 1000	= 2.0	Weight kg/1000	= 26.6
e	= 5	r min	= 0.7		
FN kN	= 74.0	s	= 2.46		